

Data Sheet



Article number: 025799200073

Description: Norma Connect pipe coupling
GRIP E W4 Ø=73,0 EPDM, 16 bar

Measures

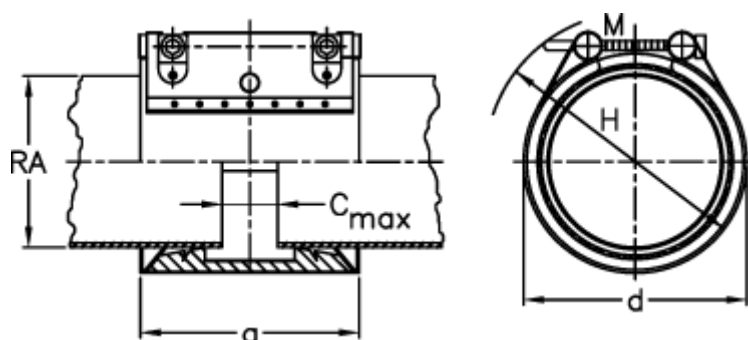

a	= 98
C max with insertion band	= 25
d	= 95
H	= 115
M (screw)	= M10
Nominal pressure (bar)	= 16
RA	= 73
RA min-RA max	= 72,6-74,0

Weight a piece = 1.4